

四级核心词汇讲义

主讲人：李达



扫码关注
橙啦 changenow



扫码关注
橙啦业务线二维码（需要替换）

•你是否。。。

- 1、单词太多；
- 2、背了就忘；
- 3、不会读写；
- 4、文中不认识；
- 5、背了不会用

•第 1 组 家族词汇: nov

novel/'nɒvl/n. 小说 *adj.* _____

_____ nov _____ /'ɪnəveɪt/v. 创新

_____ nov _____ /ɪnə'veɪʃn/n. 创新

_____ nov _____ /'ɪnəveɪtɪv/*adj.* 创新的

_____ nov _____ /'ɪnəveɪtə (r)/n. 创新者

_____ /rɪ'njuː/v. 使续期; 重新开始; 更新

renew _____ /rɪ'njuːəbl/*adj.* 可再生的

_____ -renewable/'nɒn rɪ'njuːəbl/*adj.* 不可再生的

eg: They prefer to go after all that is novel.(2021.12.1)

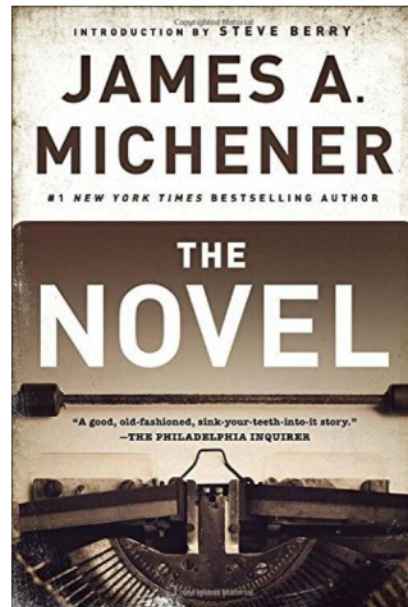

•第 2 组 家族词汇: port

_____ port/'eəpɔ:t/n. 机场

_____ port/ɪk'spɔ:t/n/v. 出口

_____ port/'ɪmpɔ:t/n/v. 进口

_____ port/træn'spɔ:t/v/n. 运输; 交通运输; 交通车辆

_____ portation/ˌtræns'pɔ:t'eɪʃn/n. 运输; 运输工具; 运输系统

_____ port/'pɑ:spɔ:t/n. 护照

_____ /'vi:zə/n. 签证



eg: It is important to understand what causes your stress in the first place.(2021.12.1)

•第 3 组 家族词汇: cover

_____ /'kʌvə (r)/v. 遮盖; 包含; 覆盖; 报道 n. 封面

_____ cover/rɪ'kʌvə (r)/v. 康复

_____ cove _____ /rɪ'kʌvəri/n. 康复

_____ cover/dɪ'skʌvə (r)/v. 发现

_____ cove _____ /dɪ'skʌvəri/n. 发现

eg: The stock market shows signs of recovery.(2020.12.1)



•第 4 组 家族词汇: -age

age/eɪdʒ/n. 年龄; _____ v. _____

_____ /'eɪdʒɪŋ/n. 老化; 老龄化

_____ /'ævərɪdʒ/adj. 平均的; 普通的 n. 平均; 平均数

man _____ /'mænɪdʒ/v. _____

manage _____ /'mænɪdʒmənt/n. 管理

short _____ /'ʃɔ:tɪdʒ/n. _____

advant _____ /əd'vɑ:ntɪdʒ/n. 优势; 利益

_____ advant _____ /ɪdɪsəd'vɑ:ntɪdʒ/n. 缺点; 不利条件

_____ /'dæmɪdʒ/n. 损害 v. 损毁

message/'mesɪdʒ/n. _____ v. _____

marriage/'mæɪdʒ/n. _____

wage/weɪdʒ/n. _____

_____ /'pækɪdʒ/n. 包裹 v. 打包

_____ /'ɪmɪdʒ/n. 影像; 想象 v. 想象; 反映; 象征

luggage/'lʌgɪdʒ/n. _____

_____ /steɪdʒ/n. 舞台; 阶段

eg: Saying “no” is an important skill to develop at any stage of your career.(2022.12.3)



•第 5 组 家族词汇: fer

- _____ fer/prɪ'fɜ: (r)/v. 较喜欢
- _____ fer _____ /'prefrəns/n. 偏爱
- _____ /'dɪfə (r)/v. 不同于
- _____ different/in'dɪfrənt/adj. 漠不关心的
- _____ /'ɒfə (r)/v. 提供 n. 工作邀请, 入学邀请
- _____ fer/'sʌfə (r)/v. 受苦; 遭受
- _____ fer _____ /'kɒnfərəns/n. 会议
- _____ fer/in'fɜ: (r)/v. 推断
- _____ /rɪ'fɜ: (r)/v. 查阅; 参考; 提及
- _____ ference/'refrəns/n. 参考, 参考书
- _____ fere/ɪntə'fɪə (r)/v. 干涉
- _____ ference/ɪntə'fɪərəns/n. 干涉
- _____ fer/træns'fɜ: (r)/v. 转学, 调动; 转移 n. 换乘



eg: Hundreds of studies show that infants prefer novelty.(2021.12.1)

•第 6 组 家族词汇: mean

_____ /mi:n/v. 表示……意思; 本意是; 打算 *adj.* 吝啬的; 刻薄的

_____ /mi:nz/n. 方式; 方法; 途径

mean _____ /'mi:nɪŋ/n. 意义; 意思

mean _____ /'mi:nɪŋfl/*adj.* _____

mean _____ /'mi:nwaɪl/*adv.* 同时



eg: What affects our health in the most meaningful ways has more to do with how we treat one another.(2022.9.1)

•第 7 组 家族词汇: view

_____ /vju:/v. _____ n. _____

_____ /rɪ'vju:/n. 回顾; 复习; 评论 v. 复习

_____ view/'pri:vju:/n/v. 预习, 预告, 预示

_____ /'ɪntəvju:/n. 面试 v. 采访

_____ view _____ /'ɪntəvju:ə (r)/n. 面试官

_____ view _____ /,ɪntəvju:'i:/n. 面试者

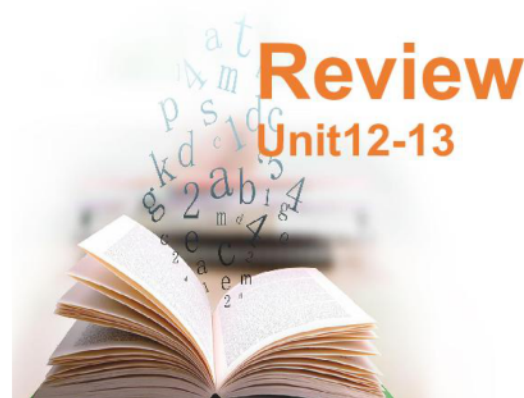

eg: However, remember to take the reviews you read.(2022.6.1)

•第 8 组 家族词汇: fess

profess _____ /prə'fesə (r)/n. 教授

_____ /prə'feʃn/n. 职业; 行业

profess _____ /prə'feʃənl/adj. 专业的; 职业的

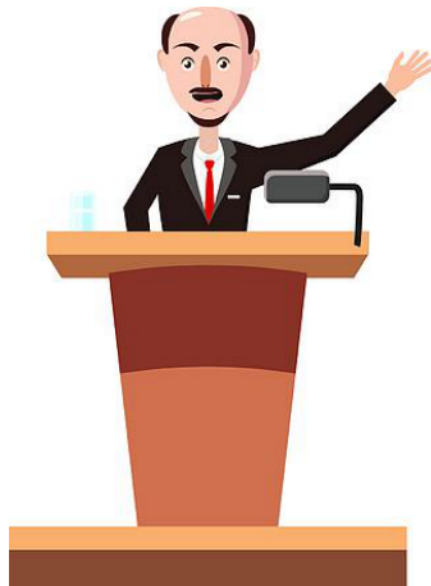

eg: Women should seek professional support if they experience severe stress.(2021.12.1)

•第 9 组 家族词汇: valu

_____ /'vælju:/n. 价值 v. 重视

valu _____ /'væljuəbl/adj. 宝贵的

value _____ /'vælju:ləs/adj. 不值钱的

_____ valu _____ /ɪ'væljueɪt/v. 评价

_____ val _____ /ɪ'kwɪvələnt/adj. 相等的

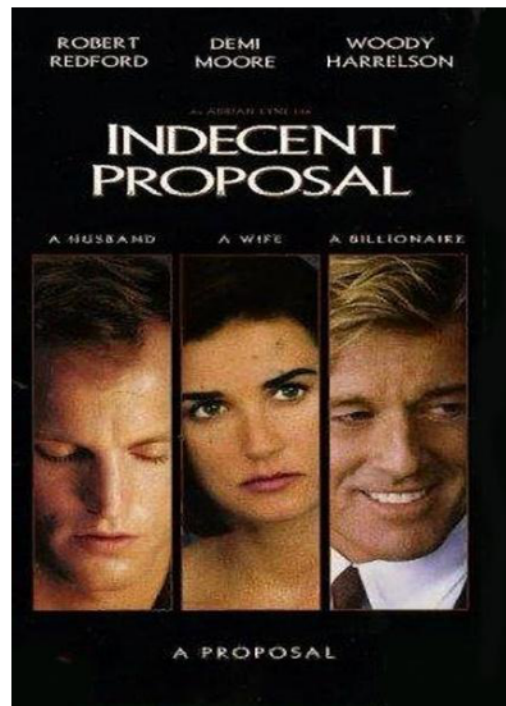

eg: I value my culture and tradition, I have a lot of pride in that.
(2021.12.1)

•第10组 家族词汇: cre

_____ /kri'eɪt/v. 创造; 创作; 造成

crea _____ /kri'eɪtɪv/adj. 创造性的; 有创造力的

creat _____ /ˌkri:ɛɪ'tɪvəti/n. 创造力

creat _____ /kri'eɪtə(r)/n. 创造者

crea _____ /kri'eɪʃn/n. 创造; 产物

crea _____ /'kri:tʃə(r)/n. 生物; 动物



eg: Roosters and chickens are not particularly strong creatures.
(2023.6.3)

•第11组 家族词汇: fac/fec

fact _____ /'fæktə (r)/n. 因素

_____ facture/ˌmænju'fæktʃə (r)/n/v. 制造

_____ factur _____ /ˌmænju'fæktʃərə (r)/n. 制造商

_____ /ɪ'fekt/n. 效果 v. 产生

effec _____ /ɪ'fektɪv/adj. 有效果的

effec _____ /ɪ'fektɪvli/adv. 有效地

_____ /ɪ'fɪʃnt/adj. 有效率的, 高效的

efficien _____ /ɪ'fɪʃnsi/n. 效率; 效能

_____ /sə'fɪʃnt/adj. 足够的

feasible/'fi:zəbl/adj. _____

_____ /ə'fekt/v. 影响; 感染

perfect/'pɜ:fɪkt/adj. 完美的 v. _____

fac _____ /fə'sɪləti/n. 设施

_____ /fə'sɪləteɪt/v. 促进; 使便利

fac _____ /'fæklti/n. 科, 系; 能力; 全体教员

_____ fice/'sækrɪfaɪs/n. 牺牲; 祭品 v. 牺牲; 献祭

eg: Develop more effective anti-cheating strategies.
(2022.9)



•第12组 家族词汇: form

_____ /fɔ:m/n. 类型; 形式, 样式; 表格

form _____ /'fɔ:ml/adj. 正式的

_____ form _____ /ɪn'fɔ:ml/adj. 非正式的

_____ /,ɪnfə'meɪʃn/n. 信息; 消息

_____ /ɪn'fɔ:m/v. 通知; 告发

perform/pə'fɔ:m/v. 执行; 表演

perform _____ /pə'fɔ:məns/n. 性能; 绩效; 表演

_____ form/'plætfɔ:m/n. 平台

_____ form/rɪ'fɔ:m/n. 改革 v. 改革

_____ form/træns'fɔ:m/v. 改变

form _____ /'fɔ:mə (r)/adj. 从前的; 前者的



eg: Organizations should reconsider the appropriateness of their performance evaluation procedures in light of the shift to remote work. (2022.9)

•第13组 家族词汇: cess/ceed/cede

橙啦 四六级

_____ cess/sək'ses/n. 成功

_____ ceed/sək'si:d/v. 成功; 继承

_____ /'prəʊses/n. 过程; 进程 v. 加工; 处理

_____ ced _____ /prə'si:dʒə (r)/n. 程序, 步骤

_____ cess _____ /sək'sesfl/adj. 成功的

_____ /'ækses/n. 方法; 途径; 渠道

_____ cession/rɪ'seʃn/n. 衰退; 不景气

_____ cess/ɪk'ses/n. 超过; 过度 adj. 额外的

_____ ceed/ɪk'si:d/v. 超过

_____ cess _____ /ɪk'sesi:v/adj. 过多的

_____ ces _____ /'ænestə (r)/n. 祖先; 始祖

eg: Organizations should reconsider the appropriateness of their performance evaluation procedures in light of the shift to remote work. (2022.9)

•第14组 家族词汇: car/cur

_____ /kɔː (r)/n. 果核; 核心 *adj.* 核心的; 主要的

_____ /keə (r)/n. 照料 *v.* 关心; 关注

care _____ /'keələs/*adj.* 粗心的

curi _____ /'kjʊəriəs/*adj.* 好奇的

curios _____ /'kjʊəri'ɒsəti/*n.* 好奇心

eg: The concept of self-care, at its core, is quite simple. (2021.12.1)



•第15组 家族词汇: duc/duct



- _____ /'edʒukeɪt/v. _____
- _____ duc _____ /'edʒu'keɪʃn/n. 教育; 培养
- _____ duc _____ /'edʒu'keɪʃənl/adj. 教育的; 有教育意义的
- _____ duce /'ɪntrə'dju:s/v. 介绍; 引进
- _____ duc _____ /'ɪntrə'dʌkʃn/n. 介绍; 引进
- _____ /'prɒdʌkt/n. 产品; 产物
- _____ product /'baɪ prɒdʌkt/n. 副产品
- produc _____ /prə'dʌkʃn/n. 生产; 制造
- produ _____ /prə'dju:s/v. _____
- produc _____ /prə'dju:sə (r)/n. 生产商
- produc _____ /prə'dʌktɪv/adj. 多产的; 有成效的
- produc _____ /'prɒdʌk'tɪvəti/n. 生产力; 生产率
- _____ duct /kən'dʌkt/n. 行为 v. 实施; 引导; 指挥; 表现
- _____ duce /ɪn'dju:s/v. 诱导; 导致
- _____ duce /rɪ'dju:s/v. 减少; 降低
- _____ duc _____ /rɪ'dʌkʃn/n. 减少; 下降
- _____ produce /'rɪ:prə'dju:s/v. 复制; 繁殖
- _____ produc _____ /'rɪ:prə'dʌkʃn/n. 繁殖; 复制

eg: They conducted large-scale research on the role of sugar in people's health. (2021.6.2)

•第 1 5 组 家族词汇: quire/quest/quer

_____ /'kwestʃən/*n.* 问题 *v.* 质疑; 怀疑

_____ quest/rɪ'kwest/*n.* 请求 *v.* 需要

_____ quire/rɪ'kwaɪə (r)/*v.* 需要; 要求; 规定

_____ quire _____ /rɪ'kwaɪəmənt/*n.* 要求; 必要条件

_____ quire/ə'kwaɪə (r)/*v.* 获得; 取得

_____ quire/in'kwaɪə (r)/*v.* 询问; 查究

_____ quer/'kɒŋkə (r)/*v.* 征服



eg: They rarely fulfil the course requirements. (2022.6.1)

•第 1 6 组 家族词汇: just/jur/jud

_____ /dʒʌdʒ/ *v.* 判断; 评判 *n.* 法官; 裁判员

_____ /dʒʌst/ *adj.* _____ *adv.* 正好; 刚才

just _____ /'dʒʌstɪs/ *n.* 公平; 公正

just _____ /'dʒʌstɪfaɪ/ *v.* 证明……正确; 为……辩护

_____ just/ə'dʒʌst/ *v.* _____

_____ just _____ /ə'dʒʌstmənt/ *n.* 调整; 适应

_____ /'ɪndʒə (r)/ *v.* 伤害

_____ /'ɪndʒəri/ *n.* 伤害

eg: The students then had to give job talks in front of judges who displayed serious facial expressions.
(2022.12.2)

JUSTICE



MAC P



•第17组 家族词汇: lead

_____ /li:d/v. 领导; 引导; 导致

_____ /'li:də (r)/n. 领导者

lead _____ /'li:dɪŋ/adj. 最重要的, 最主要的, 领先的

leader _____ /'li:dəʃɪp/n. 领导; 领导地位

_____ lead/ɪmɪs'li:d/v. _____

_____ lead _____ /ɪmɪs'li:dɪŋ/adj. _____

eg: But curiosity can also be dangerous, leading to setbacks or even downfalls. (2021.12.1)

•第 18 组 家族词汇: text/test

_____ /tekst/*n.* 课文; 文本 *v.* 发短信

text _____ /'tekstbʊk/*n.* 课本

_____ text/'kɒntekst/*n.* 背景; 上下文

_____ /test/*n.* 试验; 测试 *v.* 试验; 测试

_____ test/'kɒntest/*v.* 争辩; 竞争 *n.* 竞赛; 争论

_____ test/'prəʊtest/*v.* 抗议 *n.* 抗议



eg: Sometimes, however, testing out a new idea can lead to disaster. (2021.12.1)

•第 19 组 家族词汇: tend/tens/tent

_____ /tend/v. 照料; 趋向

tend _____ /'tendənsi/n. 倾向; 趋势

_____ /ə'tend/v. 出席; 照料

attend _____ /ə'tendəns/n. 出席

atten _____ /ə'tenfən/n. 注意力

_____ tend/ɪk'stend/v. 延伸; 扩展

_____ tent/ɪk'stent/n. 程度; 范围

_____ tension/ɪk'stenʃn/n. 延长; 扩展; 延长部分

_____ tens _____ /ɪk'stensɪv/adj. 广泛的; 大量的

_____ tend/ɪn'tend/v. 打算; 想要

_____ tent _____ /ɪn'tenfən/n. 意图

_____ /tent/n. 帐篷

_____ /'kɒntent/n. 内容; 目录 adj. 满意的 v. 使满足

_____ /tens/adj. 紧张的; 绷紧的 n. 时态

tens _____ /'tenʃn/n. 张力; 紧张 v. 使紧张; 拉紧

_____ tense/ɪn'tens/adj. 强烈的

_____ tens _____ /ɪn'tensɪv/adj. 加强的; 集中的



eg: They tend to be more open in interpersonal relationships. (2021.12.3)

•第20组 家族词汇: sign

_____ /saɪn/*n.* 符号; 迹象 *v.* 签署; 签名

sign _____ /'sɪgnətʃə (r)/*n.* 签名; 署名

sign _____ /'sɪgnəl/*n.* 信号 *v.* 发信号; 示意

signific _____ /sɪɡ'nɪfɪkənt/*adj.* 有重大意义的

_____ /ə'saɪn/*v.* 分配; 指派

assign _____ /ə'saɪnmənt/*n.* 任务; 分派

_____ /rɪ'zaɪn/*v.* 辞职

_____ /dɪ'zaɪn/*v.* 设计; 构思 *n.* 设计; 图案

_____ sign _____ /dɪ'zaɪnə (r)/*n.* 设计师; 谋划者



eg: In certain Arabian, African, and Asian countries, men can publicly hold hands or show physical affection as signs of brotherhood or friendship. (2021.12.3)

•第21组 家族词汇: cap/cup/cept/ceive

- _____ /ək'sept/v. 承认; 接受
- _____ cept _____ /ək'septəbl/adj. 可接受的
- _____ /rɪ'si:v/v. 收到; 招待; 接待
- _____ cept/'kɒnsept/n. 观念
- _____ cept/ɪk'sept/conj. 除了 *prep.* 除……之外
- _____ cept _____ /ɪk'sepʃn/n. 例外
- _____ ception _____ /ɪk'sepʃənɪ/adj. 异常的; 例外的; 卓越的
- _____ ceive/pə'si:v/v. 察觉; 理解
- _____ /kə'pæsəti/n. 能力; 容量; 资格
- cap _____ /'kæptʃə(r)/v. 俘获; 捕捉 *n.* 捕获
- _____ cip _____ /æn'tɪsɪpeɪt/v. 预期; 预料
- _____ cip _____ /pɑ:'tɪsɪpeɪt/v. 参与
- particip _____ /pɑ:'tɪsɪpənt/n. 参加者
- occupation/ˌɒkjʊ'peɪʃn/n. _____



eg: ...enhance their capacity to flourish in an increasingly harsh labor market. (2022.6.2)

•第22组 家族词汇: spec/spect

_____ /'æspekt/n. 方面; 外貌

_____ /ɪk'spekt/v. 预料; 预期

expect _____ /,ɪkspek'teɪʃn/n. 预期; 期待

_____ expect _____ /,ɪnɪk'spektɪd/adj. 出乎意料的

_____ spect/rɪ'spekt/n./v. 尊敬; 尊重

respect _____ /rɪ'spektfl/adj. 尊敬的; 有礼貌的

respect _____ /rɪ'spektəbl/adj. 值得尊敬的

respec _____ /rɪ'spektɪvli/adv. 分别; 各自

_____ spect/'prɒspekt/n. 前途; 预期; 景色

_____ spect/'sʌspekt/n. 嫌疑犯/sə'spekt/v. 怀疑; 猜想

_____ spec _____ /pə'spektɪv/n. 观点; 远景

special/'speʃl/adj. _____

special _____ /'speʃəlɪst/n. 专家

spec _____ /'spesɪfaɪ/v. 具体说明

special _____ /'speʃəlaɪz/v. 专门研究

_____ /'speʃəlti/n. 特产

especially/ɪ'speʃəli/adv. _____

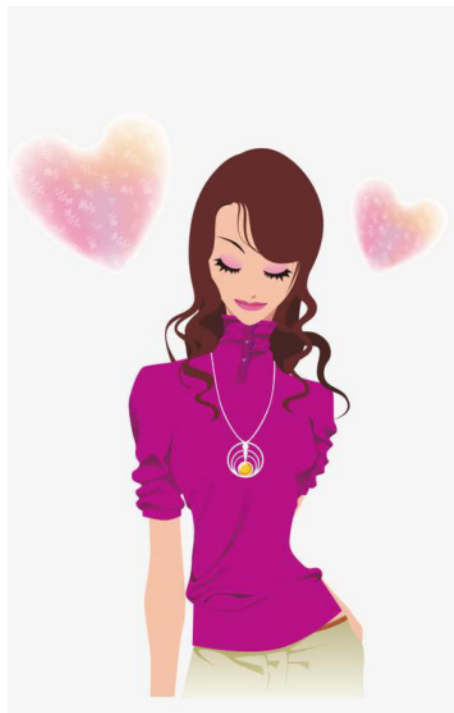

eg: ...said Ali Hajji, a solar energy specialist and engineering professor.. (2023.6.2)

•第23组 家族词汇: max/min

_____ /'meɪdʒə (r)/ *adj.* 主要的; 主修的 *n.* 主修科目 *v.* 主修

major _____ /mə'dʒɔːrəti/ *n.* 多数

_____ /mæs/ *n.* 群众; 大量; 质量 *adj.* 大规模的

mas _____ /'mæsiːv/ *adj.* 巨大的

_____ imum /'mæksɪmə/ *n.* 最大限度; 最大量

_____ /'mɪni/ *n.* 迷你型 *adj.* 微型的; 袖珍的

minute /'mɪnɪt/ *n.* 分钟; 片刻

minute /maɪ'nju:t/ *adj.* _____

_____ /'maɪnə (r)/ *adj.* 次要的; 较小的 *n.* 未成年人; 辅修科目

minor _____ /maɪ'nɔːrəti/ *n.* 少数; 少数民族; 未成年

_____ mum /'mɪnɪmə/ *n.* 最低限度

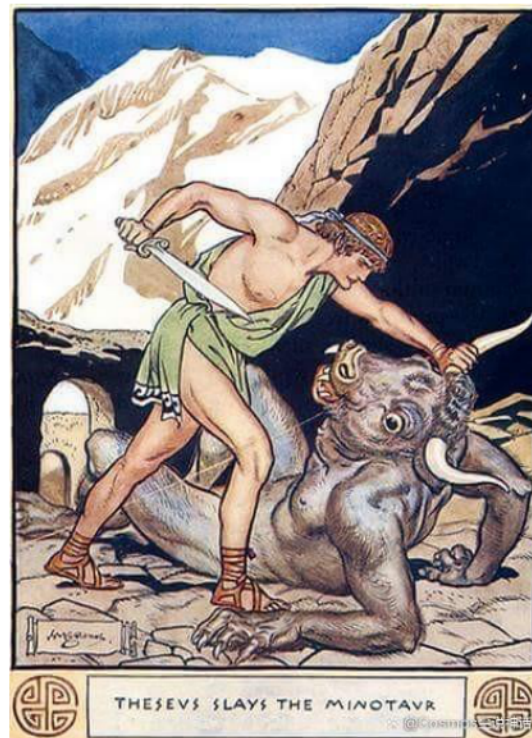

eg: For example, in one task, research participants were instructed to create new college majors by combining two or more existing academic Arts or Science programs at their university.(2021.12)

•第24组 家族词汇: volv

_____ /'vɒljʊ:m/n. 容量; 体积; 音量; 卷, 册

_____ /ɪn'vɒlv/v. 包含; 卷入; 参与

involve _____ /ɪn'vɒlvmənt/n. 参与

_____ volve/i'vɒlv/v. 发展; 进化

_____ volu _____ /,i:və'lu:ʃn/n. 进化; 演变

_____ volution _____ /,i:və'lu:ʃənəri/adj. 进化的; 演变的

_____ volu _____ /,revə'lu:ʃn/n. 革命

_____ volution _____ /,revə'lu:ʃənəri/adj. 革命的



eg: When it comes to looking for a new job, you already know that a big part of the interview process involves the company evaluating whether or not you're a good fit for their open role.(2022.6)

•第25组 家族词汇: mark

_____ /mɑ:k/n. 符号; 标志; 分数 v. 做记号

_____ /rɪ'mɑ:k/n. 言辞 v. 评论

remark _____ /rɪ'mɑ:kəbl/adj. 卓越的; 非凡的

_____ /'mɑ:dʒɪn/n. 边缘; 利润; 页边的空白

margin _____ /'mɑ:dʒɪnl/adj. 微不足道的; 边际的

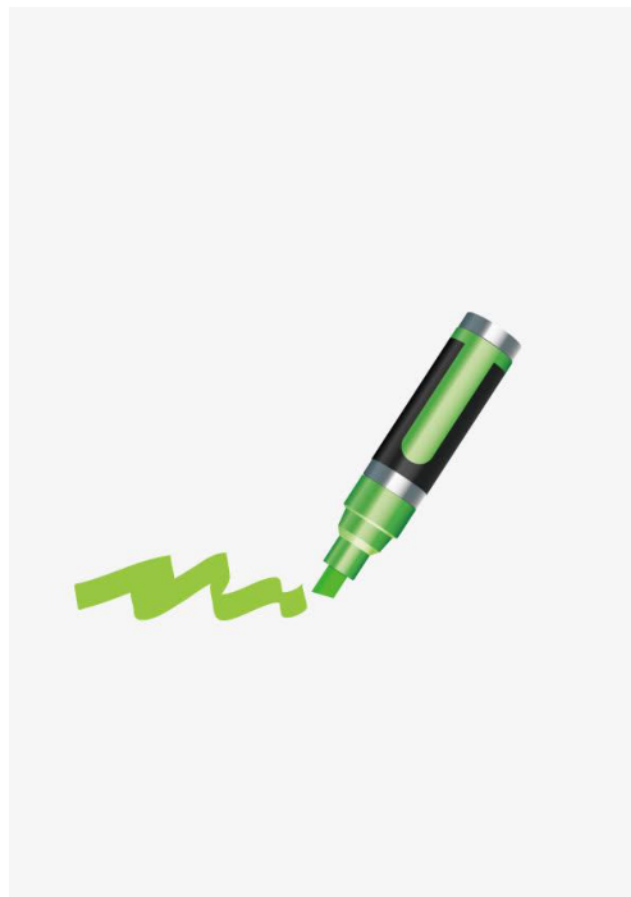

eg: They are made convenient to mark.(2022.6)

•第26组 家族词汇: pose

- _____ /pəʊz/v. 造成; 摆姿势 *n.* 姿势
- _____ pose/ɪk'spəʊz/v. 揭露; 使曝光
- _____ pos _____ /ɪk'spəʊzə (r)/*n.* 暴露; 揭露
- _____ pose/ɪm'pəʊz/v. 迫使
- _____ pose/prə'pəʊz/v. 建议; 打算; 求婚
- _____ pos _____ /prə'pəʊzl/*n.* 提议; 求婚
- _____ pose/ə'pəʊz/v. 反对
- _____ posite/'ɒpəzɪt/*n.* 对立面 *adj.* 相反的; 对立的 *adv.* 在对面
- _____ posi _____ /,ɒpə'zɪʃn/*n.* 反对
- _____ pose/dɪ'spəʊz/v. 处理; 布置
- _____ pos _____ /dɪ'spəʊzəbl/*adj.* 一次性的
- _____ /'pɜ:pəs/*n.* 目的; 用途
- _____ /sə'pəʊz/v. 假设; 认为

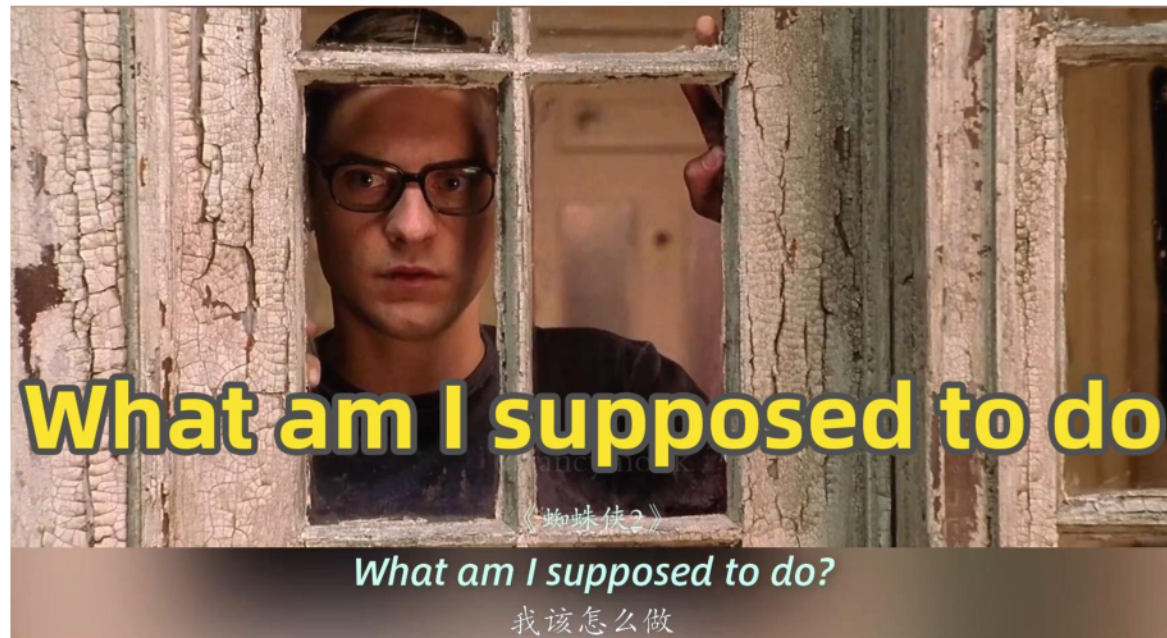

eg: The purpose of performance evaluation is ultimately to determine how to reward employees for their work.
(2022.9)

•第27组 家族词汇: uni

_____ /juˈni:k/adj. 唯一的

_____ /ˈju:ni:t/n. 单位; 单元

uni _____ /ˈju:ni:fɔ:m/n. 制服

_____ /juˈnaɪt/v. 联合

_____ /juˈnaɪtɪd/adj. 联合的; 统一的

_____ /ˈju:niən/n. 同盟

uni _____ /ˈju:ni:vɜ:s/n. 宇宙

_____ /ju:niˈvɜ:sl/adj. 全世界的; 普遍存在的



eg: Employers can also consider how to bundle different types of compensation to help employees cope with their unique situations.(2022.9)

•第28组 家族词汇: cycl

_____ cycle/'baɪsɪkl/n. 自行车

_____ /'saɪkl/n. 循环 v. 使循环

_____ /,ri:'saɪkl/v. 回收利用

recycl _____ /,ri:'saɪkləbl/adj. 可回收利用的

_____ recyclable/'nɒn,ri:'saɪkləbl/adj. 不可回收利用的



eg: Sending products for recycling leaves them vulnerable to being stolen and sold on the black market.(2021.12)

•第29组 家族词汇: str

_____ /stres/*n.* 紧张; 压力; 强调 *v.* 强调

stress _____ /'stresfl/*adj.* 压力重的

_____ /strikt/*adj.* 严格的

_____ strict/rɪ'strikt/*v.* 限制

restric _____ /rɪ'strɪkʃn/*n.* 限制

_____ strain/rɪ'streɪn/*v.* 制止; 抑制



eg: Ms. Li said her stress led to sleeplessness.
(2021.12)

•第30组 家族词汇: mob/mot

mob _____ /'məʊbaɪl/ *adj.* 可移动的

mob _____ /məʊ'bi:ləti/ *n.* 流动性

_____ mobile/'ɔ:təməbi:l/ *n.* 汽车

mot _____ /'məʊʃn/ *n.* 提议; 运动; 移动

motiv _____ /'məʊtɪveɪt/ *v.* 激励; 激发

mo _____ /'məʊtɪv/ *n.* 动机; 原因

motiv _____ /,məʊtɪ'veɪʃn/ *n.* 动力; 积极性; 动机

_____ /prə'məʊt/ *v.* 晋升; 促进; 促

promo _____ /prə'məʊʃn/ *n.* 晋升; 促销; 促进

_____ /ɪ'məʊʃn/ *n.* 情绪

emotion _____ /ɪ'məʊʃənl/ *adj.* 情绪的; 情绪激动的; 情感的

_____ mote/rɪ'məʊt/ *adj.* 偏远的; 久远的

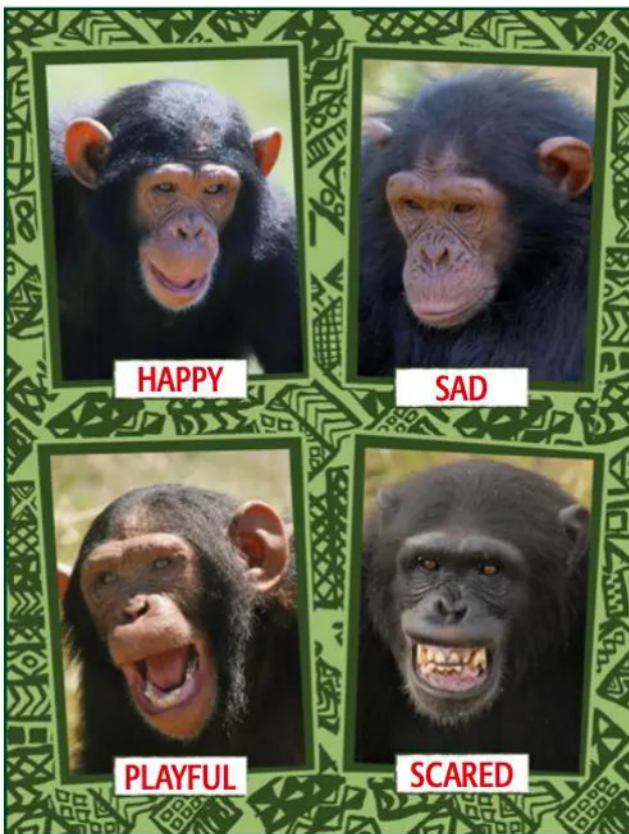

eg: As many office workers adapt to remote work, cities may undergo fundamental change if offices remain under-utilized.(2021.12)

•第31组 家族词汇: vary

_____ /'veəri/ *v.* 变化, 变更

_____ /'veəriəs/ *adj.* 各种各样的

_____ /və'raɪəti/ *n.* 多样化

vari _____ /'veəriəbl/ *adj.* 多变的

_____ variab _____ /ɪn'veəriəbli/ *adv.* 始终如一地



eg: It tends to vary with the platform used.(2022.6)

•第32组 家族词汇: tribut

_____ tribute/kən'trɪbjʊ:t/v. 贡献; 奉献, 捐款

_____ tribu _____ /,kɒntrɪ'bjʊ:ʃn/n. 贡献, 奉献

_____ /ə'trɪbjʊ:t/v. 把……归因于

_____ tribute/dɪ'strɪbjʊ:t/v. 分发; 分配

_____ tribu _____ /,dɪstrɪ'bjʊ:ʃn/n. 分发; 分配



eg: These beliefs contribute to a majority of workers connecting with colleagues on social media, even during work hours.(2022.6)

•第33组 家族词汇: apt/opt

_____ /'ɒpʃn/ *n.* 选择

_____ /'ɒpʃənl/ *adj.* 可选择的; 选修的

_____ opt/ə'dɒpt/ *v.* 收养

_____ apt/ə'dæpt/ *v.* 使适应; 改编

adept _____ /ə'dept/ *adj.* 熟练的, 娴熟的, 擅长的

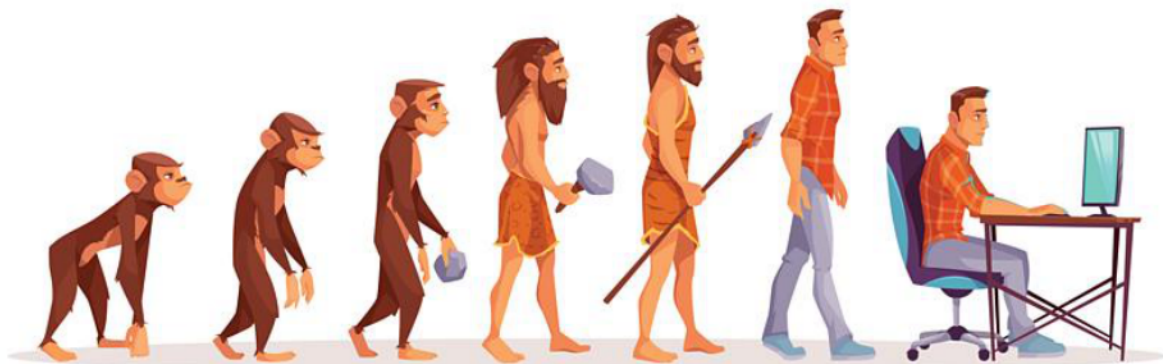

eg: The kitchen would have endless options of pizza and cookies. (2022.6)

•第34组 家族词汇: count

_____ /kaunt/v. 数; 指望; 重要; 看作

count _____ /'kauntləs/adj. 无数的

_____ /'dɪskaʊnt/n. 折扣

_____ /'kaʊntə (r)/n. 柜台

_____ /ə'kaʊnt/n. 账户; 描述 v. 解释; 导致

account _____ /ə'kaʊntənt/n. 会计

counter _____ /'kaʊntəpa:t/n. 相当的人; 对应的事物

_____ /ɪn'kaʊntə (r)/v. 遭遇, 遇到



eg: A social aspect to health has not been taken into account in trying to provide the best medical care.
(2022.9)

•第35组 家族词汇: vent

_____ vent /ɪn'vent/ v. 发明, 创造

_____ vention /ɪn'venʃn/ n. 发明, 创造

_____ vent _____ /ɪn'ventə (r)/ n. 发明家

_____ ven _____ /əd'ventʃə (r)/ n. 冒险

ven _____ /'ventʃə (r)/ v. 敢于; 冒险做 n. 冒险; 风险

_____ /prɪ'vent/ v. 防止; 阻止; 阻碍

prevent _____ /prɪ'ventəbl/ adj. 可预防的

preven _____ /prɪ'venʃn/ n. 预防

_____ ven _____ /kən'venʃn/ n. 惯例; 集会

_____ vention _____ /kən'venʃənl/ adj. 传统的

_____ /ɪntə'veɪn/ v. 干涉; 干预

intervene _____ /ɪntə'venʃn/ n. 干涉, 干预

_____ vent /ɪ'vent/ n. 重要事情

eg: As the scholar Silvia Federici put it in 1975, the unpaid nature of domestic work reinforces the assumption that "housework is not work, thus preventing women from struggling against it."(2021.12)

•第36组 家族词汇: pens/pend

_____ pense/ɪk'spens/n. 费用

_____ expensive/ˌɪnɪk'spensɪv/adj. 花费不多的, 不昂贵的

_____ ion/'penʃn/n. 养老金

_____ pens _____ /ˌkɒmpen'seɪʃn/n. 补偿 (或赔偿) 物; 赔偿金

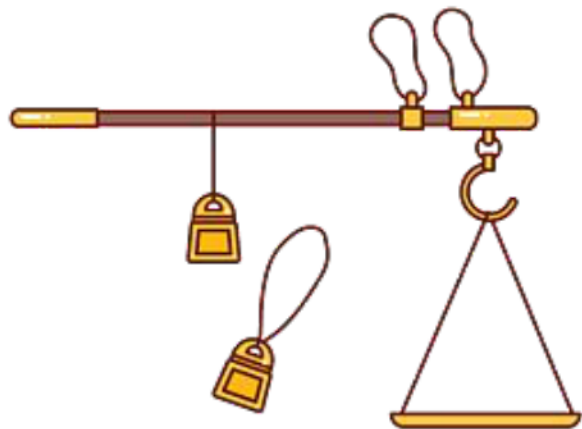

eg: Rough calculations show that the savings made by employers when their staff works from home are of similar value to the compensation workers should receive for setting up offices at home.(2021.12)

•第37组 家族词汇: tra/tract

tract _____ /'træktə (r)/n. 拖拉机

_____ /ə'trækt/v. 吸引

attract _____ /ə'træktiv/adj. 吸引人的

attrac _____ /ə'trækʃn/n. 吸引人的事或物

_____ tract/dɪ'strækt/v. 转移; 使分心

_____ traction/dɪ'strækʃn/n. 分散注意力的事; 娱乐, 消遣

_____ tract/'kɒntrækt/n. 合同 v. 签订合同

_____ tract/'æbstrækt/adj. 抽象的 n. 摘要

_____ /træk/n. 轨道; 足迹 v. 跟踪; 追踪

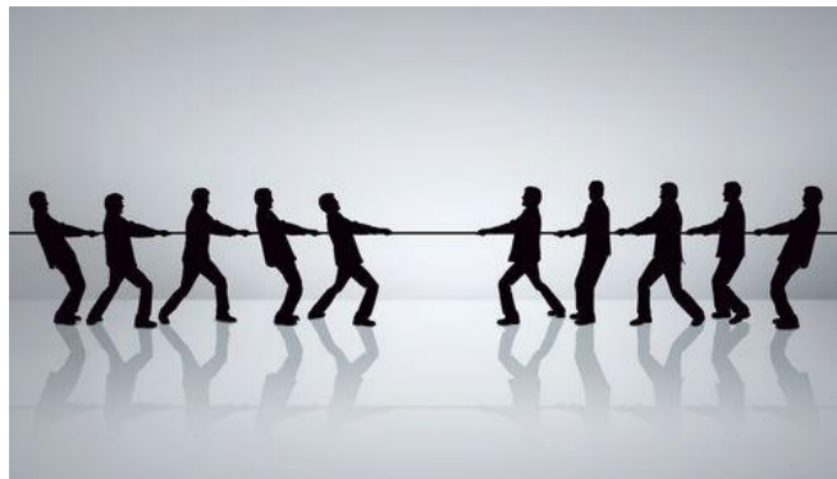

eg: employees who interact with their colleagues share meaningful work experiences, but those making connections outside the organization are distracted and unproductive.(2022.6)

•第38组 家族词汇: st/sist

_____ /ə'sɪst/v. 帮助; 援助; 促进

assist _____ /ə'sɪstənt/n. 助手

_____ /ɪn'sɪst/v. 坚持

_____ /rɪ'zɪst/v. 抵制

resist _____ /rɪ'zɪstəns/n. 抵制

_____ /kən'sɪst/v. 由……组成; 存在于

consist _____ /kən'sɪstənt/adj. 一致的

_____ /pə'sɪst/v. 顽强地坚持; 维持; 持续存在

persist _____ /pə'sɪstənt/adj. 执着的

_____ /ɪg'zɪst/v. 存在

exist _____ /ɪg'zɪstəns/n. 存在

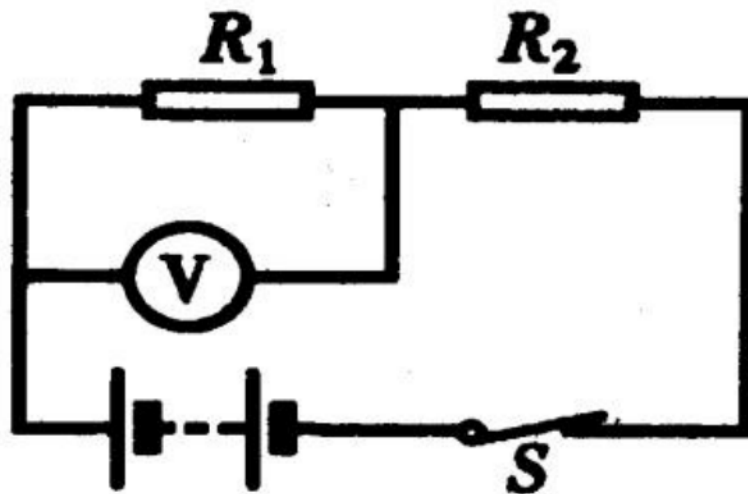

eg: As remote work is largely unobservable to supervisors, employers need to think about how they can objectively measure the quality of work in a way that is consistent for employees of similar rank.(2022.9)

•第39组 家族词汇: miss/mit

mis _____ /'mɪʃn/n. 任务

_____ mit/səb'mɪt/v. 提交, 呈递

_____ mit/træns'mɪt/v. 输送; 传播

_____ mit/i'mɪt/v. 排放; 散发 (光、热、气等)

emis _____ /i'mɪʃn/n. 排放 (物)

_____ /kə'mɪt/v. 犯, 干, 做; 承诺; 委托

commit _____ /kə'mɪtmənt/n. 承诺

commit _____ /kə'mɪti/n. 委员会

_____ mit/əd'mɪt/v. 承认; 接收 (入学); 录取

admis _____ /əd'mɪʃn/n. 承认; 准许加入

_____ /pə'mɪt/v. 允许

permis _____ /pə'mɪʃn/n. 准许; 许可



Perhaps this is because older people had fewer
ons when they were starting their careers, at a time
n values focused more on stable incomes than 32
onal missions.(2022.9)

•第40组 家族词汇: ac/ag

_____ /ækt/n. 行为; 法令 v. 行动; 扮演; 假装; 起作用

ac _____ /'ækʃn/n. 行动

ac _____ /'æktɪv/adj. 积极的

ac _____ /æk'tɪvəti/n. 活动

ag _____ /'eɪdʒənt/n. 代理人

ag _____ /'eɪdʒənsi/n. 机构; 中介

_____ /ə'dʒendə/n. 议程

_____ act/ɪntər'ækt/v. 互相影响

_____ active/ɪntər'æktɪv/adj. 交互式的; 互动的

_____ action/ɪntər'ækʃn/n. 相互作用

_____ act/ri'ækt/v. 反应

_____ action/ri'ækʃn/n. 反应

_____ act/træn'zækt/v. 办理; 交易

_____ action/træn'zækʃn/n. 交易; 办理

Professor Wilding disagrees that labelling a high proportion of the population having a disease removes responsibility or may overwhelm health services, but that other common diseases, such as high blood pressure and diabetes, require people to take action to manage their condition.(2021.12)

•第41组 家族词汇: dict

_____ /prɪ'dɪkt/v. 预言; 预报

predic _____ /prɪ'dɪkʃn/n. 预言; 预报

predict _____ /prɪ'dɪktəbl/adj. 可预见的

_____ /dɪk'teɪt/v. 口述; 强行规定; 命令

_____ /'ædɪkt/v. 使沉溺; 使上瘾 n. 上瘾的人

addic _____ /ə'dɪkʃn/n. 入迷

eg: They tell us the methods their forefathers used to predict the weather don't seem to work as well these days.(2023.6.3)

•第42组 家族词汇: en

_____ courage /ɪn'kʌrɪdʒ/ v. 鼓励

_____ /ɪn'fʊə(r)/ v. 保证; 确保

en _____ /ɪ'neɪbl/ v. 使能够

_____ /ɪn'hɑ:ns/ v. 提高; 增强

en _____ /ɪn'taɪtl/ v. 使享有权利; 叫做……

en _____ /ɪn'dʒɔɪ/ v. 享受; 享有

enjoy _____ /ɪn'dʒɔɪəbl/ adj. 使人快乐的; 令人愉快的

en _____ /ɪn'dʒʊə(r)/ v. 忍耐; 忍受

en _____ /ɪn'lɑ:dʒ/ v. 扩大; 扩充

en _____ /ɪn'rɪtʃ/ v. 使丰富

en _____ /ɪn'lɑɪtn/ v. 启发, 启蒙; 教导

en _____ /ɪn'deɪndʒə(r)/ v. 危及

en _____ /ɪn'fɔ:s/ v. 迫使

wors _____ /'wɜ:sn/ v. 恶化

_____ /'streŋθn/ v. 加强; 强化

_____ /'di:pən/ v. 变强烈; 深化

_____ /'brɔ:dn/ v. 加宽; 扩大

_____ /'taɪtn/ v. (使) 变紧; 使严格

_____ /'lu:sn/ v. (使) 变松

eg: Recent open debates on scientific research, health, and policy have aroused greater public attention and encouraged more diverse voices.(2022.6.1)

•第43组 家族词汇: serv

_____ /sɜːv/v. 招待; 服务; 可用作……

_____ /'sɜːvɪs/n. 服务; 仪式; 服役

_____ /rɪ'zɜːv/v. 预订

reserv _____ /ˌrezə'veɪʃn/n. 预订

_____ /prɪ'zɜːv/v. 保护

_____ /dɪ'zɜːv/v. 应得

_____ /kən'sɜːv/v. 保护

conserv _____ /ˌkɒnsə'veɪʃn/n. 保护

conserv _____ /kən'sɜːvətɪv/adj. 保守的

_____ /əb'zɜːv/v. 注意到

observ _____ /ˌɒbzə'veɪʃn/n. 观察

eg: He built a large consultation service to address the holistic (整体的) needs of hospitalized patients, including psychological and social factors."(2022.9)

•第44组 家族词汇: soci

_____ /'səʊʃl/ *adj.* 社会的, 社会学的; 社交的

_____ /sə'saɪəti/ *n.* 社会; 协会

_____ /ə'səʊʃieɪt/ *v.* 使联系 *adj.* 副的 *n.* 合伙人

_____ /ə,səʊʃi'eɪʃn/ *n.* 协会, 团体; 联系, 交往

_____ /'səʊʃəlaɪz/ *v.* 交往; 使适应社会

eg: There's a social dimension to health that we've completely overlooked in our efforts to find the best and most cutting-edge medical care ... (2022.9)

•第45组 家族词汇: ver/vers

- _____ /'vɜ:ʃn/n. 版本; 译文
- _____ verse/'ju:nɪvɜ:s/n. 宇宙
- _____ vers _____ /ju:nɪ'vɜ:sl/adj. 普遍的
- _____ /daɪ'vɜ:səti/n. 多样性; 差异
- _____ /daɪ'vɜ:s/adj. 多样的; 不同的
- _____ vers _____ /,kɒntrə'vɜ:ʃl/adj. 有争议的
- _____ versary/|æni'vɜ:səri/n. 周年纪念日
- _____ /rɪ'vɜ:s/v. 颠倒, 扭转; 彻底转变; 倒车
- _____ revers _____ /,rɪ'vɜ:səbl/adj. 不可逆转的; 不能挽救的

eg: While cheek-kissing for Latin Americans is also a universal greeting form, it does not require such a high degree of relational closeness. (2021.12.3)

•第46组 家族词汇: load

_____ /ləʊd/*n.* 负荷; 工作量 *v.* 装载

_____ load/ɪəʊvə'ləʊd/*v.* 超负荷; 使超载; 使负荷过重

_____ /ɪdaʊn'ləʊd/*v.* 下载

_____ load/ɪʌp'ləʊd/*v.* 上传

_____ load/'wɜ:kləʊd/*n.* 工作量

eg:

•第47组 家族词汇: flect

flex _____ /'fleksəbl/ *adj.* 灵活的

_____ flexible/ɪn'fleksəbl/ *adj.* 僵化的

flex _____ /,fleksə'bɪləti/ *n.* 柔韧性

_____ /rɪ'flekt/ *v.* 反映; 反射; 反思

reflec _____ /rɪ'flekʃn/ *n.* 反思; 反映

eg: Qualities like flexibility and the ability to work under minimal supervision might become critical.(2022.6.2)

•第48组 家族词汇: crit

critic _____ /'krɪtɪsaɪz/v. 批评

critic _____ /'krɪtɪsɪzəm/n. 批评

crit _____ /'krɪtɪk/n. 评论家

_____ /'krɪtɪkl/adj. 批评的; 关键的; 极为重要的

criter _____ /kraɪ'tɪəriən/n. 准则

eg: Qualities like flexibility and the ability to work under minimal supervision might become critical.(2022.9)

•第49组 家族词汇: migr

migr _____ /maɪ'greɪt/v. 迁移; 迁徙

migra _____ /maɪ'greɪʃn/n. 迁移; 移居; 迁徙

migr _____ /'maɪgrənt/n. (为工作) 移居者; 移民; 候鸟

_____ migr _____ /'ɪmɪgrənt/n. (外来) 移民; 外侨

_____ migra _____ /,ɪmɪ'greɪʃn/n. 移居 (入境); 移民人数

_____ migr _____ /'emɪgreɪt/v. 移居国外; 移民

eg: The U.S. was founded by successive waves of immigrants, and immigrants are still contributing to America today—statistics prove it. (2023.6.2)

•第50组 家族词汇: norm

_____ /nɔ:m/n. 准则

norm _____ /'nɔ:ml/adj. 正常的; 一般的

_____ norm _____ /æb'nɔ:ml/adj. 反常的

_____ norm _____ /ɪ'nɔ:məs/adj. 巨大的

eg: In the coming era of budget cuts to education, distance learning could become the norm.(2022.6.2)

•第51组 家族词汇: vis/vit

- vis _____ /'vɪzəbl/ *adj.* 看得见的
- _____ vis _____ /ɪn'vɪzəbl/ *adj.* 看不见的
- _____ /'vɪʒn/ *n.* 视野; 想象, 憧憬; 远见
- vis _____ /'vɪʒuəl/ *adj.* 视觉的
- _____ /əd'vaɪs/ *v.* 劝告; 建议
- advis _____ /əd'vaɪzəbl/ *adj.* 明智的
- _____ /rɪ'vaɪz/ *v.* 复习; 修改
- _____ vise/'su:pəvaɪz/ *v.* 监督
- supervis _____ /'su:pəvaɪzə (r)/ *n.* 监督人

eg: Fraudsters target popular seaside destinations for British tourists visiting Spain where prices can soar if demand exceeds supply.(2022.6.2)

•第52组 家族词汇: multi

_____ /'mʌltɪpl/ *adj.* 数量多的

_____ /'mʌltɪplaɪ/ *v.* 乘以; 成倍增加; 增殖

multi _____ /,mʌlti'mi:diə/ *adj.* 多媒体的

multi _____ /,mʌlti'ta:sk/ *v.* 多任务

eg: Employees with a growth mindset may be more likely to devise innovative ideas that bridge multiple areas of knowledge to achieve better solutions."(2021.12.3)

•第53组 家族词汇: dom

_____ /də'mestɪk/ *adj.* 本国的; 家庭的

_____ /'dɒmɪneɪt/ *v.* 支配; 统治; 主导

domestic _____ /də'mestɪkeɪt/ *v.* 驯养; 驯化; 使归化

_____ dɒm/'frɪ:dəm/ *n.* 自由

_____ dɒm/'wɪzdəm/ *n.* 才智

_____ dɒm/'seldəm/ *adv.* 很少

_____ /'rændəm/ *adj.* 随机的; 任意的; 胡乱的

eg: For example, the United Nations reported that women do nearly three times as much unpaid domestic work as men..(2021.12.1)

•第54组 家族词汇: rupt

- _____ rupt /ˌɪntəˈrʌpt/ *v.* 打断; 中断; 插嘴
- _____ rupt _____ /ˌɪntəˈrʌpʃn/ *n.* 打扰; 插嘴
- _____ rupt /ɪˈrʌpt/ *v.* 爆发; 喷出
- _____ /əˈbrʌpt/ *adj.* 突然的; 唐突的; 生硬的
- _____ rupt /ˈbæŋkrʌpt/ *adj.* 破产的; *v.* 使破产 *n.* 破产者
- _____ rupt /kəˈrʌpt/ *adj.* 贪污的; 腐败的 *v.* 使腐化, 堕落; 破坏
- _____ ruptive /dɪsˈrʌptɪv/ *adj.* 颠覆性的; 破坏性的

eg: Uncontrolled tourism development has become a primary driver of social and environmental disruption.(2022.9)

•第55组 家族词汇: point

_____ /pɔɪnt/n. 观点; 重点; 目的; 地点; 分数 v. 指向

_____ /ə'pɔɪnt/v. 任命; 指定; 约定

_____ point _____ /ə'pɔɪntmənt/n. 约定; 任命

_____ appoint /ɪdɪsə'pɔɪnt/v. 使失望

_____ appoint _____ /ɪdɪsə'pɔɪntmənt/n. 失望

eg: He points out that more
than 200genes influence weight.(2021.12.2)

•第56组 家族词汇: sci

_____ /'kɒnʃəs/ *adj.* 意识到的

_____ conscious/ʌn'kɒnʃəs/ *adj.* 无知觉的

conscious _____ /'kɒnʃəsnəs/ *n.* 意识; 知觉

_____ conscious/ɪsʌb'kɒnʃəs/ *adj.* 潜意识的

_____ /ə'weə (r)/ *adj.* 意识到的; 知道的; 明白的

_____ aware/ɪnə'weə (r)/ *adj.* 没意识到的

aware _____ /ə'weənəs/ *n.* 意识

eg: Women working outside of the home should make an effort to have a conscious conversation with their partners about more equitable sharing of household and family responsibilities,"Dr. Joyce said.(2021.12.1)

•第57组 家族词汇: equ

_____ /'i:kwəl/ *adj.* 同样的; 平等的

_____ /i'kwɒləti/ *n.* 平等; 相等

_____ /ˌɪni'kwɒləti/ *n.* 不平等, 不平衡

eg: This is an issue of equality, opportunity and national conscience.

•第58组 家族词汇: clus

_____ clude/ɪn'klu:d/v. 包括

_____ clu _____ /ɪn'klu:sɪv/adj. 包容的; 包括在内的

_____ clude/ɪk'sklu:d/v. 不包括; 排除

_____ clu _____ /ɪk'sklu:sɪv/adj. 独有的; 排外的; 独家的

_____ clude/kən'klu:d/v. 作出结论

_____ clusion/kən'klu:ʒn/n. 结论

eg: Her year-long service included comforting AIDS patients at a free health clinic and delivering meals to the homebound.(2022.9)

•第59组 家族词汇: tail

tail _____ /'teɪlə (r)/*n.* 裁缝 *v.* 剪裁; 使合适

_____ /'di:teɪl/*n.* 细节; 详情

_____ tail/'ri:teɪl/*n.* 零售 *v.* 零售

_____ tail _____ /'ri:teɪlə (r)/*n.* 零售商

eg: But some experts worried that such public speculation might lead people to believe that disagreement about the details meant a lack of adequate scientific consensus over the safety and efficiency of modern-day medicine.(2022.6.1)

•第60组 家族词汇: struct

_____ /'strʌktʃə (r)/n. 结构

_____ struct _____ /kən'strʌkʃn/n. 建筑; 建筑业

_____ struct/kən'strʌkt/v. 建造

_____ struct _____ /kən'strʌktɪv/adj. 建设性的; 建造的

_____ struct _____ /'ɪnfərə'strʌktʃə (r)/n. 基础设施

_____ struct/ɪn'strʌkt/v. 指示; 教导

_____ struct _____ /ɪn'strʌkʃn/n. 指令; 指导; 用法说明

eg: This means that pay structures need to adapt to the reality of working from home.(2022.9)

•第61组 家族词汇: riv

_____ /ə'raɪv/v. 到达, 抵达

arriv _____ /ə'raɪvl/n. 到达, 抵达

_____ /'raɪvl/n. 竞争对手 v. 与……相匹敌

_____ /dɪ'raɪv/v. 起源于

_____ /θraɪv/v. 繁荣, 兴旺; 茁壮成长

eg: It's likely that the "first to arrive and last to leave" mentality is no longer relevant, but should be replaced by a regard for the quality of an employee's contribution to the organization.(2022.9)

•第62组 家族词汇: place

_____ /pleɪs/n. 地方 v. _____

_____ place/'wɜ:kpleɪs/n. 工作场所

_____ place/'faɪəpleɪs/n. 壁炉

_____ place/rɪ'pleɪs/v. 取代

_____ place _____ /rɪ'pleɪsmənt/n. 取代

eg: It is also by far the world's most expensive place to get sick.(2022.9)

•第63组 家族词汇: part

_____ /pa:t/n. 部分; 区域; 角色 v. 离开; 分别

_____ part/ə'pa:t/adv. 分离着 adj. 分离的

part _____ /'pa:tli/adv. 部分地

part _____ /'pa:tnə (r)/n. 同伴

partner _____ /'pa:tnəʃɪp/n. 伙伴关系

depart _____ /dɪ'pa:tmənt/n. 部门; 系

apart _____ /ə'pa:tmənt/n. 公寓

particip _____ /pɑ:'tɪsɪpənt/n. 参加者

_____ part/'kauntəpa:t/n. 相当的人; 对应的事物

_____ part/dɪ'pa:t/v. 离开

_____ part _____ /dɪ'pa:tʃə (r)/n. 离开

eg: If working from home becomes permanent, employees will have to dedicate part of their private space to work..(2021.12.1)

•第64组 家族词汇: cult

_____ /'kʌltʃə (r)/n. 文化; 文明

_____ /'kʌltʃərəl/adj. 文化的

cultiv _____ /'kʌltɪveɪt/v. 培养; 栽种

_____ culture/'ægrɪkʌltʃə (r)/n. 农业; 农学

_____ cultural/ˌægrɪ'kʌltʃərəl/adj. 农业的

eg: Physically attending school has hidden benefits: getting up every morning interacting with peers, and building relationships with teachers are essential skills to cultivate in young people.(2022.6.2)

•第65组 家族词汇: base

_____ /beɪs/ *v.* 以……为基础 *n.* 基地; 底部

_____ /'beɪsɪk/ *adj.* 基本的

_____ /'beɪsɪs/ *n.* 基础

basic _____ /'beɪsɪkli/ *adv.* 主要地, 基本上

eg: It's an enduring responsibility based on the socialized gender role of women..(2021.12.1)

•第66组 家族词汇: elect

_____ /ɪ'lektrɪk/ *adj.* 带电的

elect _____ /ɪ'lektrɒn/ *n.* 电子

electron _____ /ɪ,lek'trɒnɪk/ *adj.* 电子的

electric _____ /ɪ,lek'trɪsəti/ *n.* 电

electric _____ /ɪ'lektrɪkl/ *adj.* 和电相关的

eg: Prevent students from overusing electronic devices..(2022.9)

•第67组 家族词汇: tact

_____ /tʌtʃ/ *v.* 接触, 触摸 *n.* 触碰

_____ /'kɒntækt/ *n.* 联系; 熟人 *v.* 联系

_____ /ə'tætʃ/ *v.* 贴, 系, 把……附 (在……上)

_____ /ɪn'tækt/ *adj.* 完好无损的

eg: Educational videos may deliver academic content, but they are unable to make eye contact or assess a student's level of engagement..(2022.6.2)

•第68组 家族词汇: lec

_____ /kə'lekt/v. 收集

collec _____ /kə'lekʃn/n. 收藏品

_____ /ɪ'lekt/v. 选举

elec _____ /ɪ'lekʃn/n. 选举

elec _____ /ɪ'lektɪv/adj. 选修的; 选举的 n. 选修课程

_____ /sɪ'lekt/v. 选择

_____ lec _____ /sɪ'lektɪv/adj. 选择性的; 可选的

_____ lect/'ɪntəlekt/n. 智力

_____ lig _____ /ɪn'telɪdʒənt/adj. 聪明的

_____ lect _____ /ɪntə'lektʃuəl/adj. 智力的

_____ /nɪ'glekt/v. 疏忽

eg: It is a collection of facts and established rules.(2022.6.2)

•第69组 家族词汇: regul

regul _____ /ˌregjuˈleɪʃn/ *n.* 管理; 规则; 章程

regul _____ /ˈregjuleɪt/ *v.* 约束; 管理; 调节

regul _____ /ˈregjələ (r)/ *adj.* 有规律的

regular _____ /ˈregjələli/ *adv.* 有规律地

_____ regular /ɪˈregjələ (r)/ *adj.* 不规则的; 无规律的

eg: They are frequently scheduled at irregular times.(2022.6.1)

•第70组 家族词汇: pet

_____ /kəm'pi:t/v. 竞争; 对抗

competit _____ /kəm'petɪtə (r)/n. 对手

compet _____ /'kɒmpɪtənt/adj. 足以胜任的; 有能力的

competi _____ /kəm'petətɪv/adj. 竞争激烈的; 有竞争力的; 一心

求胜的

competi _____ /kɒmpə'tɪʃn/n. 竞争

_____ /'æpɪtaɪt/n. 胃口, 食欲

eg: Prepare students to be competitive in the future..(2022.6.2)

THANKS



扫码关注
橙啦 changenow



扫码关注
橙啦业务线二维码